



# ALUPANEL

aluminium composite panel

## Fabrication Guidelines



|                                    |         |
|------------------------------------|---------|
| Product description                | 3       |
| Safety instructions                | 4       |
| Packaging                          | 4       |
| Handling                           | 4       |
| Storage                            | 4       |
| Visual consistency                 | 5       |
| Sawing                             | 6 & 7   |
| Routing and folding                | 8 & 9   |
| Corner cutting and bending         | 10      |
| Drilling, Joining techniques       | 11 & 12 |
| Welding                            | 13      |
| Off-line coating                   | 14      |
| Printing                           | 14      |
| Cleaning                           | 15      |
| Thermal Expansion                  | 16 - 18 |
| Wind load calculation              | 19 - 22 |
| Notes                              | 23      |
| Appendix 1 - Fixings & accessories |         |
| Appendix 2 - Machine manufacturers |         |

**UK Head Office**

Unit 6, Site 2, Oak Business Units, Thorverton Road, Matford, Exeter, Devon EX2, 8FS

Tel: +44 (0) 1392 823015

**UK Manufacturing Site**

Unit 2 Millyard Way, Eythorne, Dover, Kent CT15 4NL

Tel: +44 (0) 1304 831319

**USA Office**

Tel: +1 718 841 9940

[www.multipaneluk.co.uk](http://www.multipaneluk.co.uk)

Alupanel is a high-performance composite material consisting of two aluminium sheets bonded to an extruded thermoplastic core. As a result of this technology, we have created a perfectly flat and very formable material with an excellent strength-to-weight ratio.

Alupanel is supplied with a face PE paint finish, available in the widest colour range on the market.

The versatility of the panel makes it a perfect material for sign makers, designers, architects, fabricators and installers.

Advantages include:

- Exceptional rigidity
- Outstanding strength to weight ratio
- Simple to fabricate
- Easy and quick to install
- High resistance to atmospheric conditions
- Easy to maintain

**Aluminium Skin**

0.3 mm A5005 alloy high-grade aluminium offering better performance, improved rigidity and excellent processing characteristics for easier cutting, bending, etc.

**Core**

High quality PE or fire-retardant core.

**Adhesive**

Co-extruded to give superior adhesion.

**Paint Finish**

Available in a wide range of colours and finishes, painted Alupanel is a dual-sided sheet with one side in high gloss and the reverse in a matt finish.

**Protective Film**

Designed to protect the panel during storage, transit and installation.

This manual has been developed to assist fabricators and installers to work with Alupanel in the most efficient manner possible. The following recommendations and product data are based on information which is, in our opinion, reliable. However, since skill, judgment, and quality of equipment and tools are involved, and since conditions and methods of using Alupanel are beyond our control, the suggestions contained in this manual are provided without guarantee. We recommend that prospective users determine the suitability of both the material and recommendations before adopting them on a commercial scale. In no event does Multipanel UK Ltd, have any liability in any way related to or arising from said suggestions and product data for direct, special, consequential or any other damages of any kind.

Standard health and safety precautions should be adhered to when fabricating Alupanel

### Safety

Goggles or other face protection, as well as hearing protection and gloves should always be worn. An SDS for Alupanel is available from your local sales representative or distributor.

### Packaging

Alupanel comes as standard with a clear protective film, designed to be removed just before installation to offer protection from surface damage. Although the protective film is UV stabilised, it should be removed as soon as possible after installation, especially in the case of panels exposed to sunlight and adverse weather.

### Handling

Alupanel should be handled with care, especially when dealing with long lengths. It is advisable that a small team carry out the handling. When removing panels from a pallet / stack never drag the panel, always lift clear above the remaining panels on the stack. This will require two or more operatives.

### Storage

- Check the pallets and panels for completeness and transport or moisture damage. Have any complaints confirmed by the freight forwarder on the shipping documents and report them.
- The pallets should be protected from rain, splash water and penetrating moisture. In order to avoid staining or corrosion, panels that have become wet must be dried before storage and protected from condensation.
- Alupanel is packed in wooden pallets and can usually be stacked up to four pallets high.
- Please note that the Alupanel and Multishield should not be stored for longer than 6 months if possible. If the panels are stored beyond that, they must be cleaned with a lint-free cloth after removing the protective film.
- Temperature fluctuations reduce the long-term durability of the protective film. This must be removed when used outdoors. If the protective film is partially detached, dirty edges that are difficult to remove can appear over time.

When storing unpacked Alupanel please observe the following guidelines :

- To prevent warping or bending, store horizontally.
- Avoid stacking different formats (heavier pallets below) and make sure that there are no foreign objects between them, which could leave marks on the panels.
- Preferably, store them by size in racks.
- If storing panels vertically by leaning them against a rack, lay a rubber mat underneath and lean the Alupanel closely against the fixed back.
- It is advisable to store Alupanel in a clean dry area with a minimum temperature of 15°C for a duration of 24 hours before use. After 24 hours of storage you will be able to start the processing requirements for each panel. After Alupanel has been removed from the stack it must be protected from any penetrating moisture.



### Visual consistency

Each of our product types has special characteristics that can affect the visual consistency from batch to batch and even from panel to panel. It is important that these characteristics be considered when planning how to use and install Alupanel.

### Solid colours

The industry standard for allowable variation for panel to panel and batch to batch is Delta E 1.0 or less in a hunter colour space. Brighter colours, such as reds, yellows, blues, etc, which tend to be less opaque and which depend somewhat on film build (paint thickness) to achieve their appearance, will be more likely to exhibit more variation than subdued colours.

### Metallic colours

The industry standard for colour variation with metallic is Delta E 2.5 or less, much larger than the standard for solid colours. In coating the flakes will tend to align in one direction which greatly increases the directionality of the panel's appearance.

### Production batches

In order to maintain overall visual consistency, it is highly recommended that material from the same production batch is used for the entire project.

### Directional arrows

For these reasons the panels must be installed with the directional arrows all aligned in the same direction. Batches should not be mixed on a building face without first contacting Multipanel UK Ltd for a confirmation that they are visually similar enough to be used together.

Before fabrication, remember to use a felt tip pen to draw arrows to indicate the coating direction on any small pieces that might be cut out from areas without the directional arrows.

## Sawing Alupanel is an easy process that can be done with ordinary commercial metal and woodworking equipment

### Sawing

Saw blades and router bits are available through independent distributors who handle cutting tools. Prior to processing large quantities, trial saw cuts should be done to evaluate both the tool working conditions and the recommended cutting speeds. For marking the panels, the use of a soft pencil is adequate. Hard marking tools should be avoided as they can fracture the Aluminium surface. It is recommended that the swarf formed during cutting should be vacuumed away with compressed air.

Due to the nature of the Alupanel it is best to move the saw blade rather than the material as no scratch will remain on the panel. If good saw cutting practices are applied and recommendations followed, the result should be clean cuts with little burr. If, despite following the recommendations, ragged cuts are produced check the following causes:

- Poor tool support
- Tool vibration
- Blunt cutting edges
- High frictional heat at the cutting edge

As Alupanel has low thermal conductivity it cannot be cooled easily with compressed air or any other means. Therefore, it is recommended to select the tool geometry and cutting conditions in such a manner so as to minimise the frictional forces developed at the cutting point and keep the resulting heat at a low level.

### Panel Saws

Panel saws provide an effective method of cutting. These saws, whether standard equipment or custom-made, perform well and have the added advantage of space saving. If a panel saw is to be used as production equipment, an industrial model should be purchased in order to obtain adequate cutting tolerances and increase the longevity of the equipment.

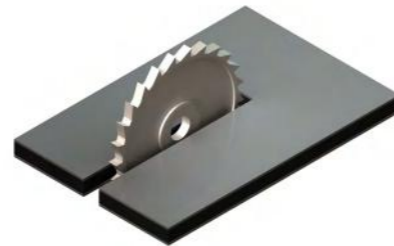

### Table Saws

Table saws are not recommended for large sheets.

### Multiple Operation Rip/V-Grooving Saws

In high production operations, equipment that is capable of performing more than one operation with a single pass through the machinery is recommended. This equipment can make multiple saw cuts (sizing the panel) and V-Grooves (rout) at the same time.



### Cutting Multishield Steel Composite without generating sparks



### Portable Circular Saws

Cutting Alupanel with portable circular saws is another effective method. As mentioned, this equipment should also be production/industrial standard equipment.

### Jig Saws

Jig saws work well for cut-outs. Care should be taken with portable jig saws to prevent damage to the Alupanel material surface. More than one sheet can be cut at a time by stacking panels.

If centre cutting (i.e., letter cut-outs) is required, a foam pad may be placed under the material with the blade cutting into the foam. The sheets may be clamped or secured with double-sided tape for the cutting operation. When clamping between jaws, protect the panel surface against damage.

| Working Method            | Cutting Material                   | Blade/Band Geometry   | Tooth Geometry   | Max. Cutting Speed | Max. Cutting Feed |
|---------------------------|------------------------------------|---|--|--------------------|-------------------|
| <b>Circular Saws</b>      | Carbide tipped or high speed steel | 20 x 35mm blades with maximum number of carbide teeth available, designed for cutting non-ferrous material. The blade should be ground thinner from the rim towards the centre to prevent pinching. | Angle or circular tooth, alternate bevelled, triple ground. Tooth gap wall rounded. Chip angle: 5° to 15°. Clearance angle: 10° to 30°. Tooth spacing: 4mm to 25mm, fine spacing preferable. | 5500 rpm           | 40 mm/sec         |
| <b>Band Saws</b>          | Tempered spring strip steel.       | Thickness: 0.8mm to 1.2mm<br>Width: 15mm to 25mm. Use racket or straight set.   | Skip teeth, designed for non-ferrous and ferrous materials (light metals and plastics). Tooth spacing: minimum 4 teeth per cm.   | 10000 rpm          | 25 mm/sec         |
| <b>Reciprocating saws</b> | High speed steel.                  | Thickness: 0.8mm to 1.2mm<br>Width: 5mm to 15mm).   | Hook or circular tooth with alternate angles, set or waved. Tooth spacing: 2mm to 6mm  |                    | 10 mm/sec         |

Carbon blades with 96 and 72 teeth, with negative teeth (negative sharpening teeth). Both types are satisfactory but we recommend the 96 tooth blade. Suggestions of blade manufacturers: LEITZ / FREUD / AKE / HELLER / LEUCO / ISOCELE

## Alupanel can be routed using conventional Routing machines

For accurate and precise manual folding of the Alupanel composite panels, resulting in a good finish, we recommend to route the rear of the panels to 2.5 mm thick, going through the exterior Aluminium layer, and some of the Polyethylene core. Normally the panel is grooved and folded 25-70 mm from the edge.

### Vertical panel saw

Equipped with specially shaped routing saw blades. The equipment needed is the same vertical saw as the one used for the cutting, but with a different saw blade and relevant equipment for adjusting the routing thickness.

The use of a chip collector is essential.

### Portable circular saw

A portable circular saw equipped with a suitable routing disk can be used, but only for a limited amount of processes. Note that special care should be given to the stability of the portable circular saw during processing of the material, as well as the precision of the routings with the help of the chosen guided system.

Multipanel UK can supply a suitable blade for cutting v-grooves - [click the info button for more details.](#) **INFO**

### Hand operated router

These routers are commonly available on the market for wood processing. If they are equipped with special routing bits (carbide tipped cutter) the hand operated router can be used for a limited number of processes. In this case the stability of the tool and the guide-system considerably affect the quality of the routing.



### Work directions

For shaped elements with a radius of between 2mm and 7mm proceed as follows:

The shape of the groove and its respective depth determines the folding radius. Note that smooth bending (shape forming of elements) cannot be obtained without uniform thickness of polyethylene remaining.



[Using a Keencut SteelTrak for cutting and grooving](#)



### Carbide Saw

By routing on just one side, Alupanel can be bent to create either an inside or outside corner. When a groove is bent at a 90° angle the bending radius of the final product will be 3-3.5mm and the element will elongate by 0.5-1.0mm. As such, the original panels should be cut shorter by that proportion.

#### TECHNICAL CHARACTERISTICS OF CARBIDE SAW-TIP:

- Outside diameter: 305
- No of the teeth: 24
- RPM: 3000 to 5000



### Grooving equipment

For processing a small number of panels, a router and trimmer can be used. For processing large volumes a circular saw and a grooving cutter are needed along with a lifter.

Note: Panels with a skin thickness of less than 0.25mm are not recommended for routing and folding.

|                |             | Material thickness remaining after routing<br>is usually between 1.5 - 2 times skin thickness |
|----------------|-------------|---|
| Alupanel       | <b>INFO</b> | 0.45 - 0.60 mm  |
| Alupanel Smart | <b>INFO</b> | 0.39 - 0.52 mm  |
| Alupanel XT    | <b>INFO</b> | 0.75 - 1.00 mm  |
| Multishield    | <b>INFO</b> | 0.38 - 0.50 mm  |



[Routing & folding a simple desk screen](#)

Two methods are normally used for cutting out corners to allow the forming of a cassette

#### Wood chisel

A sharp hammer blow to a wood chisel allows you to cut out the small thickness at the bottom of a routing groove with no difficulty. The wood chisel must be wider than the part to be cut out. With a little experience, good clean joints can be easily achieved.

#### Punching

This technique is the most productive, with the corners being cut out and the corner fastening holes being put in a single operation.

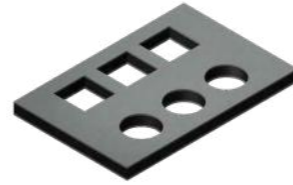

#### Minimum bending radius

The minimum bending radius for Alupanel without routing the back skin is forty times the thickness of the panel being curved, i.e. 4 mm panel thickness = 160 mm minimum radius.

#### Pyramid Roller

Alupanel can be cold formed in a pyramid roller, a press brake or over a clamped pipe. The process is similar to the forming of Aluminium; however, due to the sensitive surface, care should be taken to ensure rollers are clean, smooth and free of defects to avoid damage to the surface.

As an extra precaution, a protective film should be used between the panel and the rollers to further shield the panel surface. Do not pinch the Alupanel between the rollers. Roll the panel 3° to 5° tighter to allow for a small amount of Spring back that will occur. Once the sheet is curved; however, it will remain curved.



#### Press Brake

When forming with a press brake, use a top die (tubular) with the radius desired and open the bottom die (jaws) approximately two times the thickness of the material plus film wider than the top die. The lower die should always have a protective pad of not less than 3 mm film.

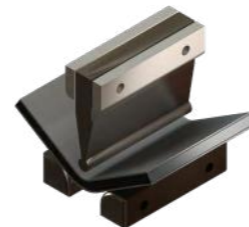

Some adjustment of the lower jaws may be necessary to allow for varying bending properties between anodized and painted finish and for varying thicknesses. The radius of the top die will be the approximate inside radius of the finished panel.

#### Bending Over a Clamped Pipe

Alupanel may be formed over a pipe of the proper diameter that is securely clamped to a work table. A hinged "leaf" attached to the end of the table will bend the material easily.

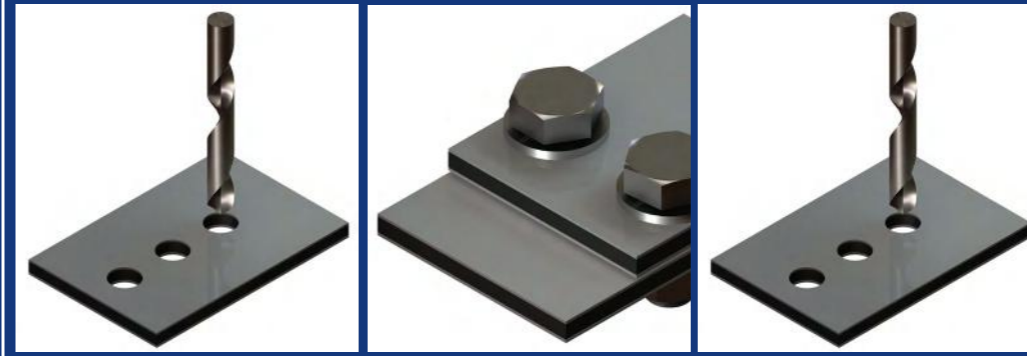

#### Drilling

Alupanel can be drilled with standard drills used for Aluminium and plastics.

#### WORKING SPECIFICATIONS:

Drill bit: Twist drill, high speed steel.

Tip Angle: 100-140 degrees, or counter-bore grind with centring tip.

Cutting speed: 164 RPM to 984 RPM.

Quick removal of chips can be achieved by a high RPM, slow feed speed and occasional lifting of the bit.

#### Joining

A variety of different fasteners are used to fabricate and install Alupanel. Structural adequacy and selection of these fasteners are the responsibility of qualified engineers and, in most instances where architectural panels are used, certified calculations will be required by the Building Official. You may successfully use specific fasteners for panel load testing purposes in obtaining building code recognition.

Please find below some important general information about joining techniques. Use the following guidelines when other elements come in direct contact with the surface of Alupanel material:

#### Acceptable joining materials

Aluminium, plastic, stainless steel, plated or coated steel with cadmium or zinc.



#### Unacceptable joining materials

Copper, brass, bronze, iron, raw steel. Unacceptable materials cause corrosion of joining surfaces due to electrolysis of dissimilar materials. Therefore, use "heavy" or "red" metals only with an electrically insulating intermediate layer.

When joining elements are to be anodized, assemble the materials after the anodizing process. Proper consideration should be given to the thermal expansion characteristics of Alupanel material when using any of the joining techniques.

#### Pop rivets

Pop rivets are often used to attach aluminium clip angles and other structural or ornamental elements to Alupanel. Because the rivet body will be in contact with the aluminium skin of the panel, it is recommended that either aluminium or stainless steel rivets be used to avoid dissimilar metals contacting. Ultimate shear and tensile strengths of various rivets are available from the rivet manufacturer.

Please be advised that some building code jurisdictions do not endorse the use of pop rivets for structural connections.

Screws are also used to perform many of the same applications as rivets.

#### Screws

Stainless steel screws are industry standard and are appropriate to avoid corrosion and dissimilar metal contact. Because screws are customarily installed through pre-drilled holes and because the Alupanel Aluminium skins are nominally 0.3 mm thick, it is recommended that sheet metal screw thread type fasteners be used, especially when the screw is under tension load and this load is resisted by the aluminium skins. Occasionally, Alupanel is face fastened directly to supports or sub-grids. The type and thickness of the support metal, as well as the applied load, will dictate the size and thread type of the correct fastener.

#### Through bolts

These provide an excellent way to join sheets of Alupanel together, or to other elements. Galvanized, stainless steel or aluminium bolts, nuts and washers should be used to avoid dissimilar metal contact.

Caution is recommended in tightening the nut onto the bolt. Because the plastic core material is compressible, over tightening can deform the metal skins. Use lock nuts or double nuts with washers to prevent the nut from loosening over time.

#### Adhesive Bonding

In addition to structural adhesives, double sided tape can be used for fixing Alupanel to flat surfaces such as walls, ceilings, furniture, coverings, etc.

Extreme care should be taken when selecting the adhesive to ensure it is chosen according to the application and the environmental conditions. Be aware that some adhesive curing processes can cause read-through; such adhesives should not be used.

To allow for thermal expansion, it is recommended to use adhesives that retain a degree of flexibility when cured.

It is important that the manufacturer is consulted prior to the usage of the adhesive for further instructions.

The substrate surface should be clean before the application of the structural adhesive.



#### Hot air welding

This method is frequently used to assemble Alupanel. The filler rod and the polyethylene core are welded together after heating by a jet of hot air projected by an electrically heated welding gun.

For good quality welding, you need:

- Good preparation of the edges to be welded together
- Adequate filler rod quality
- A good welding speed
- Evenly applied pressure
- Clean hot air
- An appropriate temperature

#### Welding by the to-and-fro method

Hold the filler rod at a right angle whilst exerting regular pressure on the rod, make to-and-fro B-B (non-circular) movements. The filler rod and the edges to be welded must be heated in a similar way.

#### Welding using a high-speed nozzle

Normal hot air guns fitted with a removable high-speed welding nozzle allow the edges to be welded and the filler rod to be heated at the same time. This makes for better quality welding. The filler rod is pushed by the constant pressure of the high-speed nozzle, and is therefore pressed between the edges to be welded.

#### Preparation of the edges to be welded

**Butt welding:** The edges must be bevelled.

**Corner assembly:** Only one of the panels is bevelled.

**T-assembly:** Remove the narrow strip of metal skin to free the areas to be welded.

**Welding of a fold:** Bevel the edges to be welded first of all using a shaped milling cutter.

The polyethylene core oxidizes relatively quickly once exposed to the air. It must be welded within a maximum of 24 hours after it is bevelled. Once it has cooled, it is possible to remove the welding flash using a knife or scraper. We recommend that this operation be carried out in a clean, oil and water-free area.

The specific welding qualities of the filler rod are:

Polyethylene: low density

Colour: unpigmented

Density: 0.9 g/cm<sup>3</sup>

Diameter of rod: 3, 4 and 5 mm

Immediately before welding, remove the outer layer of oxide from the filler rod.

Testing is advisable to determine the performance of any fastening system.

Alupanel can be coated off-line if necessary. Specialist print panels are also available

#### Off-line Coating

It is advisable to follow instructions as specified by the manufacturer of any paints to be used.

For off-line coating observe the following guidelines:

- Surface should be lightly abraded to provide a better coating surface. The Surface should then be cleaned of all contaminants i.e. dust, dirt and oil, etc. A soft cloth with a non-petroleum-based solvent (e.g. rubbing alcohol) should be used to clean the surface area.
- Curing should be done at room temperature since temperatures above 80°C (175°F) can cause Alupanel to deform.

#### Printing

Alupanel is perfect for printing with an epoxy base or urethane base two-part type ink/paint. When selecting an ink, confirm its weather ability and adhesion with the ink manufacturer. It is recommended to test the ink adhesion on the surface of Alupanel before printing.

For printing on Alupanel, observe the following guidelines:

- Remove all dust and dirt on the surface of Alupanel. Oily dirt causes splintering, splitting, or other defects of the paint. It must be completely removed with a soft cloth dipped in alcohol, N-hexane, etc. If storage or drying is not done correctly, the adhesion or other performance may be adversely affected. Therefore, observe the storing conditions of each paint as specified by the manufacturer.
- Since storing in high temperature may cause deformation, ensure the storing temperature is kept below 80°C (175°F) and store horizontally.

#### Easy-peel protective film

Easy Peel Protective Film ensures no residue is left on the panel, reducing cleaning time and eliminating the risk of interference with the print.

#### Print panels

Alupanel variants designed specifically for high quality printing include:

- A-Lite - A Signal White digital coating for improved ink adhesion and bright, intense colours.
- A-Lite White Core - Same as A-Lite but with a white core, great for applications where the panel edge is visible.
- A-Lite Latex specially developed to achieve great, long lasting results printing direct with latex inks.



[Printing on brushed finishes](#)



[Printing on Multishield Steel Composite](#)



[Printing on A-Lite](#)

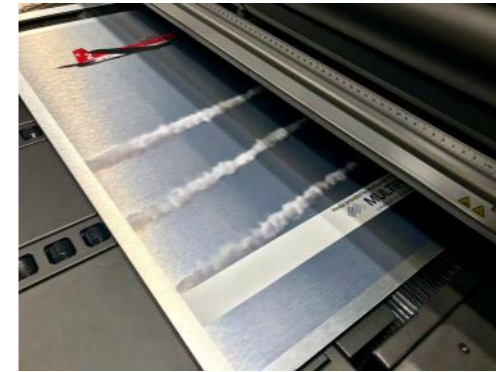

#### Cleaning

Alupanel should be regularly cleaned following the method below. The surface of the panel will commonly accumulate dust, dirt and other airborne particles. In the case of panels used externally, various hydrocarbons from airborne exhausts are also likely to need removal. It is also possible that surfaces could be contaminated with synthetic hydrocarbons from other exhausts such as synthetic grease, oil, hydraulic fluids, lubricants or stains from vegetation like plant or animal matter.

#### Cleaning Method

We recommend a 4-step cleaning method:

1. Flush Alupanel with water from a hose.
2. Wipe lightly with a soft cloth.
3. Use pressure washer.
4. Use detergent in a power wash or with a soft cloth for hand wiping and flush with water.

For mirror-type finishes, use a fleece-type material (with no liquid additives) for mirror surfaces. If the “dry” cleaning is not sufficient, use water for pre-cleaning and dry with a fleece cloth. Any liquid cleaning agent should be pH neutral and must not be abrasive in any way. Cleaning agents for glass can be used if they satisfy this criteria.

#### Alupanel & Alupanel A-Lite - pH test/print life-span

Tests have been undertaken to determine the acidity of our Alupanel and Alupanel A-Lite Digital panels. An Insta-Check pH pencil (by Micro Essential Laboratory) was used to carry out the tests. The panel surface was moistened with distilled water and left for 3 minutes. Several lines were drawn with the Insta-Check pH pencil on the wet surface. After 15 seconds the colour of the lines was compared with a pH colour chart. The colours of the lines matched the colour on the chart corresponding to a pH level of 7, which indicates that the substance is neutral.

In conclusion, we can state that the surface of our digital panels is not acidic and that coatings/paints applied will last for years. This means that Alupanel is suitable, for example, for archival applications.

#### Material Compatibility

Alupanel is an extremely durable material that has been designed to withstand significant exposure to environmental conditions. It is unlikely to be compromised by any cleaning process that would conceivably be used on the material. However, in the interests of maintaining the finish of the material, the prudent user will select products with a pH of 10 or less and which do not contain bleaches, ammonia or caustic ingredients such as sodium hydroxide, potassium hydroxide or sodium metasilicate. It is also recommended that users avoid abrasive materials or tools such as scouring powders, fibre pads or brushes.



Materials will expand and contract according to variations in temperature

**All the materials used in construction and sign making will expand when exposed to high temperatures and shrink when the temperature falls. Each material has its own thermal expansion rate. In the metric system it is measured in mm/m/100DC and shows how many millimetres one metre of material will expand when the temperature changes by 100 degrees Celsius**

For example, for steel and concrete this rate is around 1.2 mm and for PVC it is 5.2 mm. When different materials are fixed together it is always necessary to take into account their expansion rates and exposure of those materials to different temperatures.

Alupanel consists of 2 Aluminium layers bonded to a polyethylene core. Thermal expansion of Alupanel is determined by the properties of its Aluminium skins. Thermal deflection of Aluminium is 2.4 mm/m/100°C. So a 2440 mm long panel with a 100°C temperature fluctuation will expand 5.86 mm and its length will become 2445.86 mm under new temperature conditions. At the same time, if 2 edges of the panel are fixed, the tension in Aluminium skins will lead to panel bowing. Bowing deflection in this case will be 73.2 mm. It is very important to make sure that when installation is carried out in the conditions where essential temperature fluctuations are expected, fixings shall be designed to allow free thermal expansion of the panels.

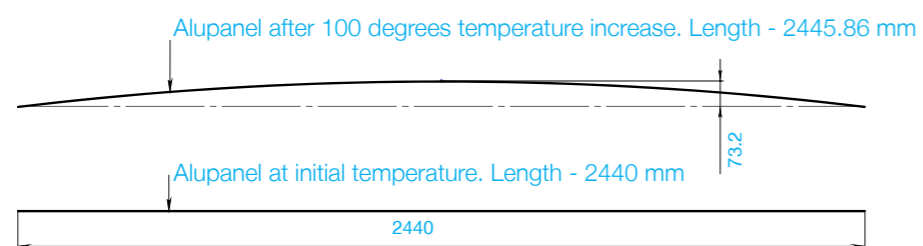

Sometimes it may happen that a substrate on which Alupanel is designed to be installed is rigidly fixed without taking thermal expansion into consideration. In this case this substrate can bow and deform causing subsequent bowing of the Alupanel which is fixed to this substrate. To prevent this, substrates on which Alupanel is going to be installed should be carefully examined.

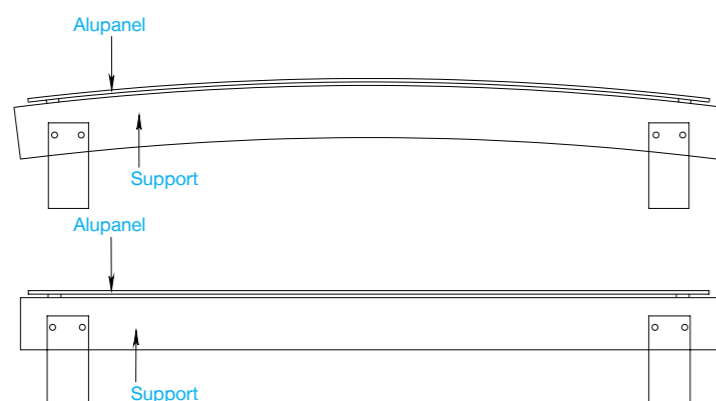

When installed outdoors under direct sunlight, Alupanel surface temperature can achieve up to 75°C for dark colours. Minimum winter value in Northern countries should be taken as -35°C. Before any installation it is very important to calculate possible thermal movements and choose the right solution to compensate taking into account materials of the subframe, temperature during installation, minimum and maximum temperatures in the installation area. Compensation of thermal expansion means that Alupanel fixing should be done to allow some freedom in fixing points so that the panel can independently slide along the subframe when shrinking or expansion of the panel differs from that of the subframe. It allows for the prevention of tension which can lead to panel bending or damage to the fixings. Channel systems and clipping systems allow free movement of the panel alongside the profile. A fixing gap should always be left between the panel edge and channel end to allow the panel to expand perpendicularly to the profile.

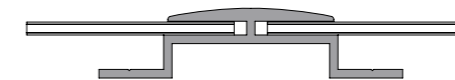

Problems with thermal movements often happen when a panel is fixed to the subframe with rivets or screws; to prevent this, special tools should be used during such installation. When Alupanel is fixed by rivets, an adjusted step drill and riveting gun with special nozzle should be used.

A step drill cuts a 5,2 mm diameter hole in the subframe profile while an 8,5 mm or bigger hole is cut in the panel. A special nozzle for riveting guns is used to prevent jamming of the rivet head into the panel surface. It fixes the rivet so that a small gap is left between the panel surface and the rivet head to allow free panel movement. Rivets with bigger heads should also be used - normally, rivets with 14 or 16 mm heads are used. When screws are used to fix Alupanel it is possible to use a step drill with the first drill radius at least 1 mm smaller than the shaft of the screw. Another option is to cut holes for the screws in Alupanel prior to installation. The radius of such holes should be calculated depending on the project to allow free panel movement. Normally at least 8,5 mm holes should be made for 5 mm screws. Screws should be carefully centred in the holes during installation. Screws should not be fixed tightly and should not jam into the Alupanel. It is recommended to turn the screw 180° to make sure it is not tight. Screws with countersunk heads should not be used.

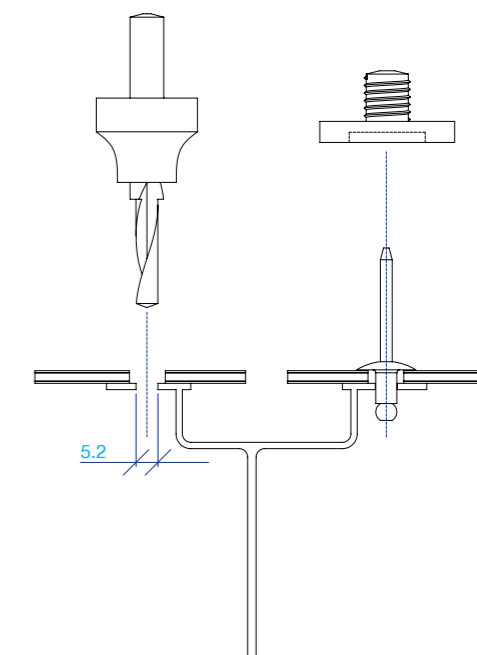

Sometimes panel length is too big and holes with a bigger diameter can not compensate for thermal movement and in such cases oval holes can be cut into the panel. At the same time, one or two round holes should be cut to keep the panel in place. A special cutting drill bit can be used to cut such holes. When a panel is fixed to more than two profiles it is recommended to make the centre of the panel tightly fixed while the sides of the panel are left loose.

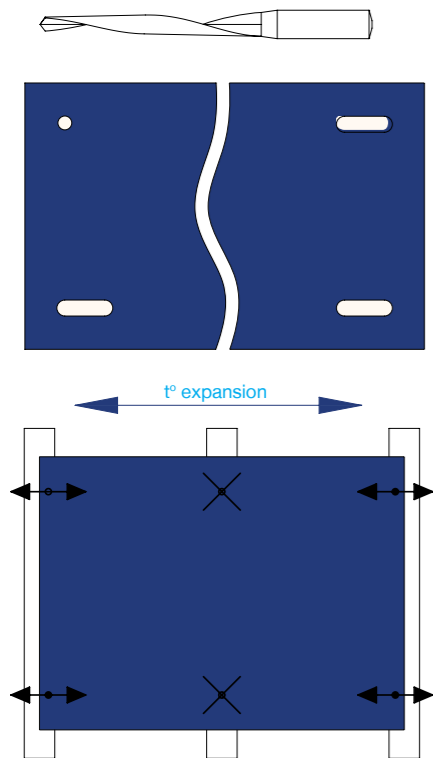

**Glue Systems**

For projects where essential thermal movements are expected only special flexible glues should be used. Normally it can be polyurethane based glues with flexibility at brake of 300% or more. It is very important to consult a representative of the glue maker to make sure the glue is suitable for the specific project. During installation you should strictly follow the glue maker's instructions.

As a general rule, glue thickness should be at least 3 mm to have a flexible joint. This can be achieved by using double-sided adhesive tapes or other spacers with the necessary height. It is recommended to apply the glue with a special nozzle forming triangle glue beads and the height of such a bead should be at least two times height of the spacer.

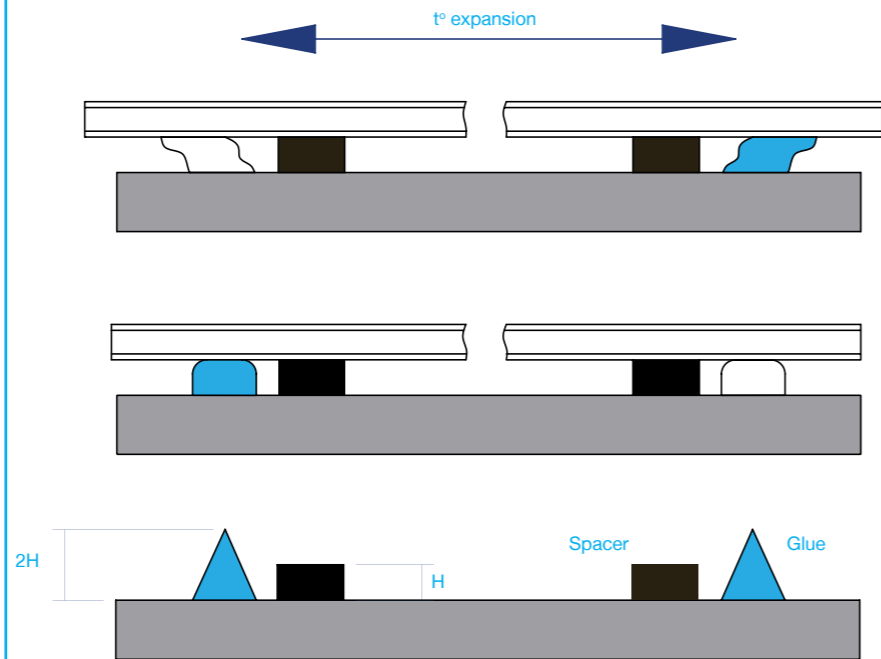

**Alupanel strength calculations:**

The composite technology of Alupanel makes the material very light and extremely rigid. For these reasons, Alupanel is used across the world in many different sign and architectural projects, including those at substantial height subjected to high wind load and wind suction conditions.

The following guide has been designed to enable easy calculations for any Alupanel project subject to windy conditions.

Alupanel presents a "truss" where characteristics of the panel are determined by characteristics of its upper and bottom Aluminium layers. Our Aluminium layers are made of Aluminium alloy with tensile yield strength of 22000psi. This is the maximum tension that material can bear before deformations become irreversible.

Alupanel is available in different thicknesses so, please refer to the following formula and table to calculate the apparent thickness of your exact Alupanel type.

T - apparent thickness of Alupanel  
 Tpanel - total thickness of Alupanel  
 Tcore - thickness of core material

$$T = \sqrt{\frac{T_{panel}^3 - T_{core}^3}{T_{panel}}}$$

The next considerations are loading and support conditions. Support conditions are determined by the installation methods used. Wind pressure and suction loads are determined by height on which panels are going to be installed and the situation of the building - local building and wind codes should be referred for this information. Depending on support conditions, different calculation methods should be used. Please choose your support conditions from the table below and use the appropriate formula from the next column to calculate the exact figure of the stress.

W - unit area load, psf

Please see table for apparent thicknesses for Alupanel types:

| Product    | Panel Thickness (mm) | Aluminium Layer Thickness (mm) | Apparent Thickness |
|------------|----------------------|--------------------------------|--------------------|
| Alupanel 2 | 2                    | 0.3                            | 0,0638             |
| Alupanel 3 | 3                    | 0.3                            | 0,0827             |
| Alupanel 4 | 4                    | 0.3                            | 0,0976             |
| Alupanel 4 | 4                    | 0.5                            | 0,1197             |
| Alupanel 6 | 6                    | 0.5                            | 0,1531             |

1. 1 side fixed, 3 sides free; evenly distributed load.

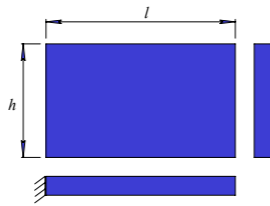

$$\sigma = \frac{3wl^2}{T^2}$$

2. 2 sides simply supported, 2 sides free; evenly distributed load.

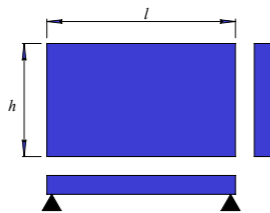

$$\sigma = \frac{3}{4} \times \frac{wl^2}{T^2}$$

3. 1 side fixed opposite side simply supported, 2 sides free; evenly distributed load.

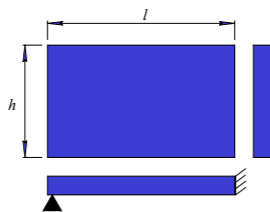

$$\sigma = \frac{3}{4} \times \frac{wl^2}{T^2}$$

4. 2 sides fixed, 2 sides free; evenly distributed load.

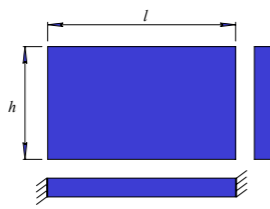

$$\sigma = \frac{1}{2} \times \frac{wl^2}{T^2}$$

5. 4 sides simply supported; evenly distributed load.

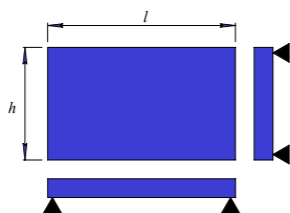

$$\sigma = \beta \times \frac{wl^2}{T^2}$$

| l/h     | 1      | 1.2    | 1.4    | 1.6    | 1.8    | 2.0    | 3.0    |
|---------|--------|--------|--------|--------|--------|--------|--------|
| $\beta$ | 0.2874 | 0.3762 | 0.4530 | 0.5172 | 0.5688 | 0.6102 | 0.7134 |

6. 4 sides fixed; evenly distributed load.

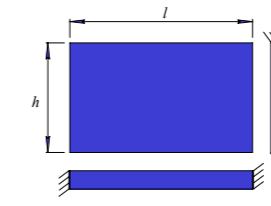

$$\sigma = \beta \times \frac{wl^2}{T^2}$$

| l/h     | 1      | 1.2    | 1.4    | 1.6    | 1.8    | 2.0    | $\infty$ |
|---------|--------|--------|--------|--------|--------|--------|----------|
| $\beta$ | 0.3087 | 0.3834 | 0.4356 | 0.4680 | 0.4872 | 0.4974 | 0.05     |

7. Longer sides fixed, shorter sides simply supported; evenly distributed load.

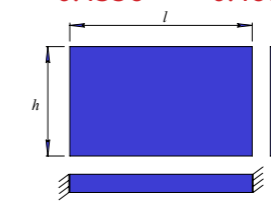

$$\sigma = \beta \times \frac{wl^2}{T^2}$$

| l/h     | 1      | 1.2    | 1.4    | 1.6    | 1.8    | 2.0    | $\infty$ |
|---------|--------|--------|--------|--------|--------|--------|----------|
| $\beta$ | 0.4182 | 0.4086 | 0.4860 | 0.4968 | 0.4971 | 0.4973 | 0.5      |

8. Longer sides simply supported, shorter sides fixed; evenly distributed load.

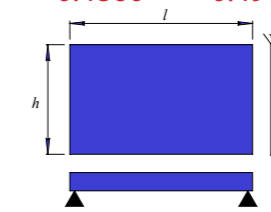

$$\sigma = \beta \times \frac{wl^2}{T^2}$$

| l/h     | 1      | 1.2    | 1.4    | 1.6    | 1.8    | 2.0    | $\infty$ |
|---------|--------|--------|--------|--------|--------|--------|----------|
| $\beta$ | 0.4182 | 0.5208 | 0.5988 | 0.6540 | 0.6912 | 0.7146 | 0.75     |

9. 1 longer side fixed, another longer side free, shorter sides simply supported; evenly distributed load.

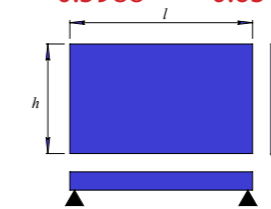

$$\sigma = \beta \times \frac{wl^2}{T^2}$$

| l/h     | 1     | 1.5   | 2     | 3     | $\infty$ |
|---------|-------|-------|-------|-------|----------|
| $\beta$ | 0.714 | 1.362 | 1.914 | 2.568 | 3        |

10. 1 shorter side free, other sides simply supported; evenly distributed load.

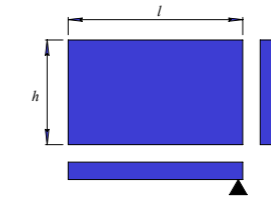

$$\sigma = \beta \times \frac{wl^2}{T^2}$$

| l/h     | 1    | 1.5  | 2    | 4   |
|---------|------|------|------|-----|
| $\beta$ | 0.67 | 0.77 | 0.79 | 0.8 |





**MULTIPANELUK**<sup>LTD</sup>  
*a multitude of applications*



[www.multipaneluk.co.uk](http://www.multipaneluk.co.uk)



# ALUPANEL

aluminium composite panel

Fabrication Guidelines

Appendix 1 - Fixings & Accessories



**The perfect colour match!** At Mainline we're all about colour and we're rather good at making your projects look the very best they can be. We can faithfully colour-match to any manufacturer's cladding panel and provide you with any fastener or profile within 4 - 7 working days. Now that's a service that's hard to match!

|                               |       |
|-------------------------------|-------|
| Colour match screws & rivets  | 3     |
| Rivets & drill bits           | 4     |
| Vent profiles                 | 5 & 6 |
| Tapes & gaskets               | 7     |
| Formoa bonding system         | 8 & 9 |
| Forbond fabrication tape      | 10    |
| Formoa colour-matched sealant | 11    |



**UK Head Office**  
 Unit 6, Site 2, Oak Business Units, Thorverton Road, Matford, Exeter, Devon EX2, 8FS  
 Tel: +44 (0) 1392 823015

**UK Manufacturing Site**  
 Unit 2 Millyard Way, Eythorne, Dover, Kent CT15 4NL  
 Tel: +44 (0) 1304 831319



**USA Office**  
 Tel: +1 718 841 9940

[www.multipaneluk.co.uk](http://www.multipaneluk.co.uk)



**Timber Fix – 8.5mm Sliding Point – No Fixed Point**

| Product   | Code          | Application   |
|---|---------------|---|
|  | SWLP 4.8 x 25 | <u>A2 Stainless Steel low-profile screw</u><br>12mm Head and a woodscrew thread<br>To face fix panels to timber |
|  | SWLP 4.8 x 38 | <u>A2 Stainless Steel low-profile screw</u><br>12mm Head and a woodscrew thread<br>To face fix panels to timber |

**Face-fix to Aluminium Sub-frame and Cassette Joint Recess Screw**

| Product   | Code                     | Application   |
|---|--------------------------|---|
|    | SWLP/SD/4.8 x 25/S       | <u>A2 Stainless Steel low-profile screw</u><br>12mm head and a self-drilling tip.<br>To face fix panels to aluminium - ECT 15mm                                       |
|   | SWLP/SD/5.5 x 35/S       | <u>A2 Stainless Steel low-profile screw</u><br>12mm head and a self-drilling tip.<br>To face fix panels to aluminium - ECT 18mm                                       |
|  | SWLP/SDR/4.8 X 19/BI/S12 | <u>Bi-metallic A2 Stainless Steel low-profile screw</u><br>12mm head and a self-drilling tip.<br>To face fix panels to aluminium and steel<br>ECT 2 – 4mm – Drive T25 |

**Side Stitching Rivet for ACM Cassettes and Flashings / Copings etc..**





| Product   | Code               | Application   |
|---|--------------------|---|
|  | RBD 4.0 x 12/AS/MG | <u>4.0 x 12 x 8mm head rivet</u><br>Grip Range 4.0 – 9.5mm<br>Aluminium body – Stainless Mandrel  |
|  | RBD 4.8 x 15/AS/MG | <u>4.8 x 15 x 9.5mm head rivet</u><br>Grip Range 4.5 – 11.0<br>Aluminium body – Stainless Mandrel |
|  | RBC 4.8 x 12/AS    | <u>4.8 x 12 x 120° head rivet</u><br>Grip Range 6.0 – 8.0mm<br>Aluminium body – Stainless Mandrel |

Panel Manufacturers do change their system from time to time.  
 If in any doubt, please check with your panel manufacturer.





t: +44(0)1782 629 270  
 e: [sales@mainlineproducts.co.uk](mailto:sales@mainlineproducts.co.uk)  
 w: [mainlineproducts.co.uk](http://mainlineproducts.co.uk)



Rivet Fix for panels under 1 Metre Wide – 7.0mm Sliding Point – No Fixed Point

| Product   | Code                | Application   |
|---|---------------------|---|
|  | SSAL5/5.0 x 12 x 11 | <u>5.0 x 12 x 11mm head rivet</u><br>Grip Range 6 – 8mm<br>AlMg5 Aluminium body – Stainless Mandrel                             |
|  | CT6551              | <u>Centralising Tool</u><br>Used on pre-drilled panels to ensure a concentric hole is drilled in the aluminium behind the panel |
|  | CT-HDRLG-5.1        | <u>Replacement drill bit</u><br>For centralising tool above   |
|  | RT/ACB/NP/AL/K11    | <u>Rivet spacer nose piece</u><br>Used to set the rivet off the panel face by 0.3mm   |
|  | STEP-051070         | <u>Step Drill</u><br>One step site drill bit for 7.0mm hole in the panel and 5.1mm hole in the rail                             |

Rivet Fix for panels over 1 Metre Wide – 8.5mm Sliding Point – No Fixed Point

| Product   | Code                | Application   |
|---|---------------------|---|
|  | SSAL5/5.0 x 12 x 14 | <u>5.0 x 12 x 14mm head rivet</u><br>Grip Range 6 – 8mm<br>AlMg5 Aluminium body – Stainless Mandrel                             |
|  | CT8051              | <u>Centralising Tool</u><br>Used on pre-drilled panels to ensure a concentric hole is drilled in the aluminium behind the panel |
|  | CT-HDRLG-5.1        | <u>Replacement drill bit</u><br>For centralising tool above   |
|  | RT/ACB/NP/AL/K14    | <u>Rivet spacer nose piece</u><br>Used to set the rivet off the panel face by 0.3mm   |
|  | STEP-051085         | <u>Step Drill</u><br>One step site drill bit for 8.5mm hole in the panel and 5.1mm hole in the rail                             |

Panel Manufacturers do change their system from time to time.  
If in any doubt, please check with your panel manufacturer.

t: +44(0)1782 629 270  
e: sales@mainlineproducts.co.uk  
w: mainlineproducts.co.uk



PVC Vent Profile

Rigid PVC Vent Profile – 2.5 Metre Length

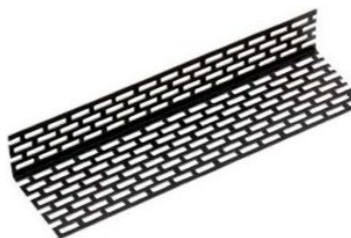
| Product   | Code          | First Diameter (mm) | Larger Diameter (mm) | Free Ventilation cross Section cm <sup>2</sup> /linear metre | Pack Size |
|---|---------------|---------------------|----------------------|--|-----------|
|  | VP/RP/2525/BL | 25                  | 25                   | 112  | 10        |
|   | VP/RP/3030/BL | 30                  | 30                   | 134  | 10        |
|   | VP/RP/3050/BL | 30                  | 50                   | 246  | 10        |
|   | VP/RP/3060/BL | 30                  | 60                   | 291  | 10        |
|   | VP/RP/3070/BL | 30                  | 70                   | 358  | 10        |
|   | VP/RP/3090/BL | 30                  | 90                   | 470  | 10        |

Vent Profile Rigid PVC

| Product   | Code           | Width (mm) | Length (Metre) | Free Ventilation cross Section cm <sup>2</sup> /linear meter | Pack Size |
|---|----------------|------------|----------------|--|-----------|
|  | VP/FP/050x5BL  | 50         | 5              | 269  | 10        |
|   | VP/FP/080x5BL  | 80         | 5              | 426  | 10        |
|   | VP/FP/100x5BL  | 100        | 5              | 538  | 10        |
|   | VP/FP/150x5BL  | 150        | 5              | 648  | 10        |
|   | VP/FP/180x5BL  | 180        | 5              | 792  | 10        |
|   | VP/FP/050x60BL | 50         | 60             | 269  | 10        |
|   | VP/FP/080x60BL | 80         | 60             | 426  | 10        |
|   | VP/FP/100x60BL | 100        | 60             | 538  | 10        |

t: +44(0)1782 629 270  
e: sales@mainlineproducts.co.uk  
w: mainlineproducts.co.uk





## Aluminium Vent Profile

## Aluminium Vent Profile – 2.5 Metre Length

| Product  | Code      | Size     | Finish      | Free Ventilation cross Section cm <sup>2</sup> /linear meter | Pack Size |
|--|-----------|----------|-------------|--|-----------|
|  | VP30030MF | 30 x 30  | Mill Finish | 92/92  | 20        |
|  | VP30040MF | 30 x 40  | Mill Finish | 92/139   | 20        |
|  | VP30050MF | 30 x 50  | Mill Finish | 92/185   | 20        |
|  | VP30060MF | 30 x 60  | Mill Finish | 208  | 10        |
|  | VP30070MF | 30 x 70  | Mill Finish | 254  | 10        |
|  | VP30090MF | 30 x 90  | Mill Finish | 346  | 10        |
|  | VP30100MF | 30 x 100 | Mill Finish | 393  | 10        |
|  | VP30120MF | 30 x 120 | Mill Finish | 462  | 10        |
|  | VP50050MF | 50 x 50  | Mill Finish | 185/185  | 20        |
|  | VP50700MF | 50 x 70  | Mill Finish | 185/255  | 20        |
|  | VP30040BL | 30 x 40  | Black       | 92/139   | 20        |
|  | VP30050BL | 30 x 50  | Black       | 92/185   | 20        |
|  | VP30060BL | 30 x 60  | Black       | 208  | 10        |
|  | VP30070BL | 30 x 70  | Black       | 254  | 10        |
|  | VP30100BL | 30 x 100 | Black       | 393  | 10        |
|  | VP30120BL | 30 x 120 | Black       | 462  | 10        |
| VP50050BL  | 50 x 50   | Black    | 185/185     | 20   |           |
| VP50070BL  | 50 x 70   | Black    | 185/255     | 20   |           |

Where Free Vent shows two figures i.e. 185/185 it is vented both sites

## Tapes and Gaskets

## EPDM Flexible Finned Gasket for Timber Batten Joints

| Product   | Code           | Description                                  |
|---|----------------|--|
|  | GAS/FIN/36/BL  | 36mm x 25 Metre Roll Flexible Finned Gasket  |
|   | GAS/FIN/60/BL  | 60mm x 25 Metre Roll Flexible Finned Gasket  |
|   | GAS/FIN/75/BL  | 75mm x 25 Metre Roll Flexible Finned Gasket  |
|   | GAS/FIN/100/BL | 100mm x 25 Metre Roll Flexible Finned Gasket |

## PVC Shadowline Tape

| Product  | Code            | Description                            |
|--|-----------------|--|
|  | GAS/SHL/040/PVC | 40mm x 33 Metre Roll Shadow Line Tape  |
|  | GAS/SHL/050/PVC | 50mm x 33 Metre Roll Shadow Line Tape  |
|  | GAS/SHL/075/PVC | 75mm x 33 Metre Roll Shadow Line Tape  |
|  | GAS/SHL/100/PVC | 100mm x 33 Metre Roll Shadow Line Tape |
|  | GAS/SHL/120/PVC | 120mm x 33 Metre Roll Shadow Line Tape |

## Blackout Tape / Anti Rattle Tape for Aluminium Sub-Frame

| Product   | Code           | Description                                       |
|---|----------------|---|
|  | GAS/FLT/SA/035 | 35mm x 25 Metre Roll Blackout / Anti Rattle Tape  |
|   | GAS/FLT/SA/050 | 50mm x 25 Metre Roll Blackout / Anti Rattle Tape  |
|   | GAS/FLT/SA/060 | 60mm x 25 Metre Roll Blackout / Anti Rattle Tape  |
|   | GAS/FLT/SA/080 | 80mm x 25 Metre Roll Blackout / Anti Rattle Tape  |
|   | GAS/FLT/SA/100 | 100mm x 25 Metre Roll Blackout / Anti Rattle Tape |

t: +44(0)1782 629 270  
e: sales@mainlineproducts.co.uk  
w: mainlineproducts.co.uk



t: +44(0)1782 629 270  
e: sales@mainlineproducts.co.uk  
w: mainlineproducts.co.uk



## FORMOA PANEL BONDING SYSTEM FOR MULTIPANEL PANELS; Alupanel, Alupanel XT,

### Product

Formoa 017FE is a High Performance single component adhesive, with medium to high viscosity and very high adhesive strength.

### Formoa Panel Bonding System Features

- Long term durability, elasticity\* and performance
- Optimal tension distribution
- Adhesion to panels tested in accord with 'AMES-006'
- Excellent moisture and weather resistance
- Fast and straight forward installation/mounting

### Formoa Panel Bonding System Consists of;

- Formoa 017FE, 290ml** High Performance Adhesive, 290ml Cartridge. Part Number 91048
- Formoa 017FE, 600ml** High Performance Adhesive, 600ml FoilSausage. Part Number 91045
- Triangular Nozzle** For applying Formoa 017FE Adhesive. Part Number 53027
- Forbond F5600** Double Sided Foam Tape, 2mm x 12mm x 40m. Part Number 73004
- Formoa Surface Activator** Simultaneous cleaner and degreaser, 1L. Part Number 92002

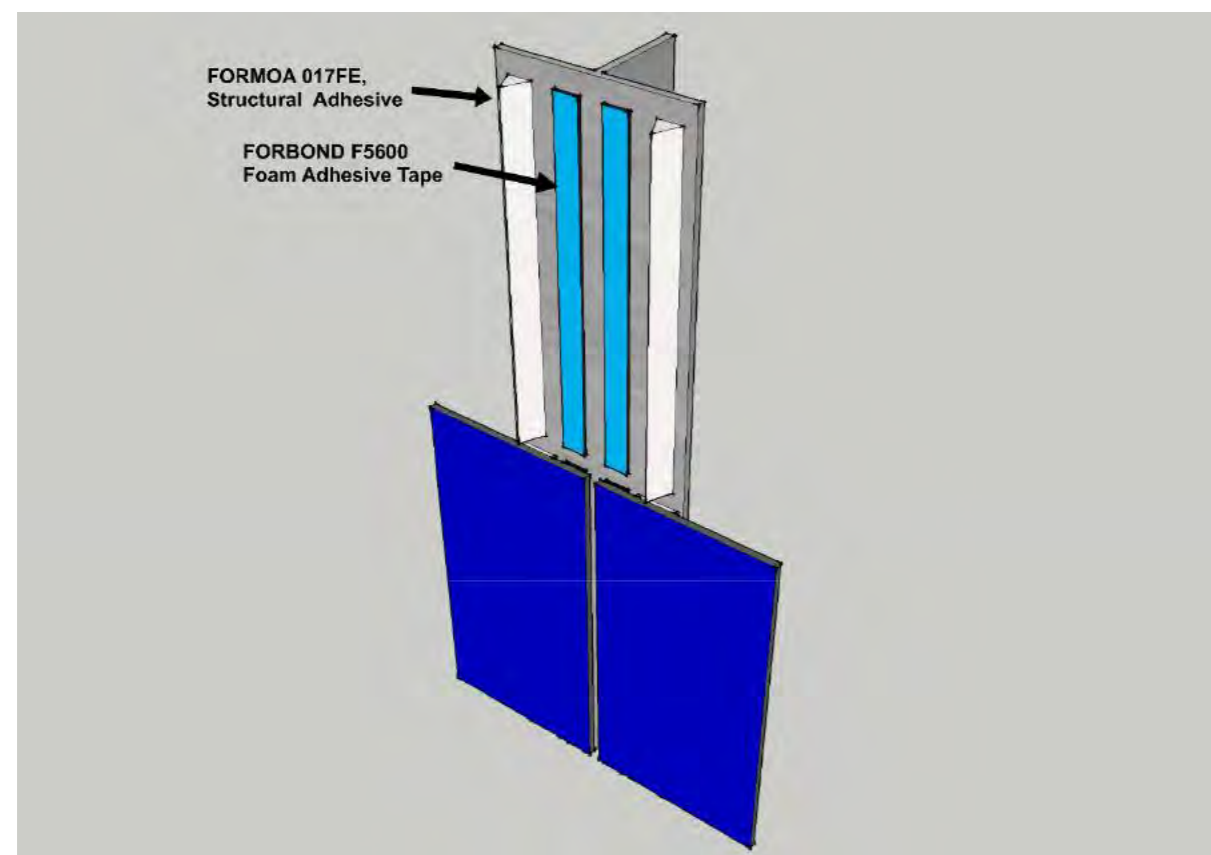

Tel: +44 (0) 1626 367 070  
E-mail; Sales@forgeway.com

CONTINUOUS DEVELOPMENT. INTELLIGENT SOLUTIONS

Forgeway Ltd / Registered Office: Collett Way, Brunel Road Industrial Estate, Newton Abbot, Devon, TQ12 4PH, UK / Company Reg No. 07230689 / Registered in England and Wales



**FORGEWAY**



### Application

The surfaces to be bonded must be clean; free from dust and grease. Use Formoa Surface activator or Suitable Industrial Solvent (Heptane, Isopropyl Alcohol) to clean mounting profile and back of the panel. When using Formoa Surface Activator, apply in one direction only using a lint free wipe. Take care to ensure Formoa Surface Activator or Industrial Solvent does not come in contact with the decorative front of the panel.

Allow 10 minutes for Formoa Surface Activator or Industrial Solvent to flash off/dry.

Apply the Forbond F5600 tape to the mounting profile and press firmly to ensure full surface contact. Before applying the tape work out the optimum position and length of tape required, bear in mind the dimensions of both the mounting profile and the panel, always ensure there is sufficient space for the adhesive (when flattened out the adhesive will cover  $\pm 20$ mm area).

Apply Formoa 017FE High Strength Adhesive to the mounting profile using a triangular nozzle.

Remove Blue Release liner from the tape.

Offer up the panels within 10-15 minutes of applying the Formoa 017FE High Strength Adhesive. Gently place the panel into the adhesive, and ensure correct positioning; small corrections are possible until the panel contacts the tape. Joint spacers can be used to aid positioning. As soon as you're satisfied with the positioning apply pressure to the bond area to ensure full surface contact with the tape. The tape will offer the initial hold to allow the adhesive time to cure.

### Cautions

Take care to ensure Formoa Surface Activator or Industrial Solvent does not come in contact with the decorative front of the panel.

After applying Formoa 017FE adhesive to the mounting profile you must not leave it for longer than 15 minutes before offering up the panel, if 15 minutes is exceeded the adhesive may start to skin over/dry and no longer offer a wet bond. If unsure how long ago the adhesives was applied a sample test can be carried out; simply touch the surface of the bead of adhesive, if wet adhesive transfers onto the finger the adhesive is still good to bond.

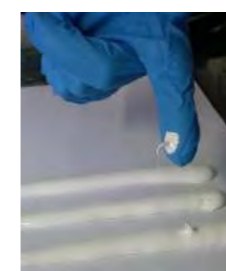

\*Formoa 017FE has an Elongation at Break of >350% (DIN 53504)

Tel: +44 (0) 1626 367 070  
E-mail; Sales@forgeway.com

CONTINUOUS DEVELOPMENT. INTELLIGENT SOLUTIONS

Forgeway Ltd / Registered Office: Collett Way, Brunel Road Industrial Estate, Newton Abbot, Devon, TQ12 4PH, UK / Company Reg No. 07230689 / Registered in England and Wales

**FORGEWAY**



## FORBOND FABRICATION TAPE FOR MULTIPANEL PANELS; Alupanel, Alupanel XT,



### Product

Forbond F4150 is an adhesive tape, incorporating a unique adhesive system that provides fast adhesive strength build, high ultimate adhesive levels and long term performance.

### Forbond Fabrication Tape Features

- Exceptional peel performance
- Distribution of stress throughout the entire bond area
- Excellent Weathering Properties
- High bond Strength, especially in joints of high movement and different thermal expansion

### Forbond Fabrication Tape System Consists of;

- Forbond F4150** Adhesive Tape, 1.1mm x 12mm x 33m. Part Number 76018  
(Also Available in other dimensions)
- IPA Surface Cleaner** For removing dust and grease from bond area prior to Applying the tape. Part Number 12007
- Hand roller** Apply pressure and ensure full surface contact. Part Number 27001

### Applications

- Panel overlap joints
- Bonding Stiffeners
- Bonding cap profiles

### Application Best Practices

- Ensure the surfaces to be joined with Forbond F4150 are clean; free of dust and grease. Use IPA surface Cleaner or a 50/50 isopropyl alcohol/water mixture to remove any contaminants, dust or grease.
- After applying the tape, apply firm pressure to the bond area to ensure full contact.

### Cautions

In temperatures below 15°C (well above our average autumn temperature of 10.9°C and winter temperature of 3.9°C) the lap shear strength (strength of bond under extreme tension) of double-sided acrylic adhesive tape can be reduced by up to 50%.

Tel: +44 (0) 1626 367 070  
E-mail; Sales@forgeway.com



## FORGEWAY

CONTINUOUS DEVELOPMENT. INTELLIGENT SOLUTIONS

Forgeway Ltd / Registered Office: Collett Way, Brunel Road Industrial Estate, Newton Abbot, Devon, TQ12 4PH, UK / Company Reg No. 07230689 / Registered in England and Wales

## FORMOA COLOUR MATCHED SEALANT FOR MULTIPANEL PANELS; Alupanel, Alupanel XT,



### Product

Formoa 010 is colour matched sealant, available in over 140 colours- every colour formulated to meet a customer need, with the ability to bespoke match to any substrate or colour reference. Formoa 010 is for applications where exact colour match is desired with no diminution in performance when exposed to extreme conditions and demanding environments.

### Formoa Colour Matched Sealant Features

- Excellent adhesion to a range of substrates
- Exceptional UV stability
- Anti-Pick Properties
- Solvent and isocyanate free
- Available in an Anti-Microbial formula for applications where exceptional hygiene is required e.g. Washrooms and Medical Environments
- Available in a Fire-Retardant formula for applications requiring rigid fire specifications

### Formoa 010 Coloured Sealant; Recommended Colour matches to Multipanel Décors

| Multipanel; Panel Colour Reference | Formoa Sealant Colour match; Part Number |
|------------------------------------|--|
| Traffic White 9016                 | 93029                                    |
| Ultra White                        | 91001                                    |
| Light Ivory 1015                   | 93060                                    |
| Traffic Grey 7042                  | 93067                                    |
| Anthracite Grey 7016               | 93030                                    |
| Ultra Marine Blue 5002             | 93038                                    |
| Blue 5022                          | 93014                                    |
| Green 6005                         | 93049                                    |
| Traffic Green 6024                 | 93276                                    |
| Traffic Yellow 1023                | 93021                                    |
| Orange 2004                        | 93019                                    |
| Traffic Red 3020                   | 93068                                    |
| Burgundy Red 3004                  | 93024                                    |
| Chocolate 8011                     | 93273                                    |
| Jet Black 9005                     | 93165                                    |
| Silver 9006                        | 93140                                    |
| Metallic Silver                    | 93140                                    |
| Brushed Aluminium                  | 93272                                    |
| Brushed Copper Gold                | 93293                                    |
| Brushed Gold                       | 93314                                    |
| Brushed Black                      | 93165                                    |

Tel: +44 (0) 1626 367 070  
E-mail; Sales@forgeway.com



## FORGEWAY

CONTINUOUS DEVELOPMENT. INTELLIGENT SOLUTIONS

Forgeway Ltd / Registered Office: Collett Way, Brunel Road Industrial Estate, Newton Abbot, Devon, TQ12 4PH, UK / Company Reg No. 07230689 / Registered in England and Wales



**MULTIPANELUK**<sup>LTD</sup>  
*a multitude of applications*



[www.multipaneluk.co.uk](http://www.multipaneluk.co.uk)



# ALUPANEL

aluminium composite panel



## Fabrication Guidelines

### Appendix 2 - Machine manufacturer information







# Recommendations by manufacturer

|                         |        |
|-------------------------|--------|
| Recommended settings    | 3      |
| Esko                    | 4      |
| Zund                    | 5      |
| Tekcel                  | 6      |
| AXYZ                    | 7      |
| Multicam                | 8      |
| Casadei                 | 9 - 11 |
| Safety Speed/Sign Saw   | 12     |
| Keencut                 | 13     |
| Fabricating Multishield | 14     |
|                         | 15     |

|                              |  |  |  |  |  |              |                    |
|------------------------------|---|---|---|---|---|--------------|--------------------|
| Maximum RPM of spindle       | 40000   | 55000   | 46600   | 24000   | 24000   | 3500         |                    |
| Tool type                    | MUS06-4006-50C1   | MUS06-4006-50C1   | R104 4 mm   | CP-AL 4-8-6   | 90deg v-groove  | 6mm end mill | 6mm spiral O upcut |
| Recommended feed rate (mm/s) | 83  | 200   | 200   | 85  | 350 approx  | 320 approx   | 244 (Production)   |

Note: All data obtained after in-house testing by manufacturer's stated above.  
 Material Tested: Alupanel 3mm (0.3)  
 For Alupanel 2mm and Alupanel Lite 2mm and 3mm, we would recommend comparable speeds as above.

We always recommend that you allow time for your own individual test procedures, depending on Machine Version and always seek advice from an experienced user. If further detail is required please contact your re-seller.

|                |   | <b>Recommended Routing Depth (mm):</b><br>Material thickness remaining after routing is usually between 1.5 - 2 times skin thickness |
|----------------|---|--|
| Alupanel       |  | 0.45 - 0.60  |
| Alupanel Smart |  | 0.39 - 0.52  |
| Alupanel XT    |  | 0.75 - 1.00  |
| Multishield    |  | 0.38 - 0.50  |

Panels with a skin thickness of less than 0.25mm are not recommended for routing and folding.

**UK Head Office**  
 Unit 6, Site 2, Oak Business Units, Thorverton Road, Matford, Exeter, Devon EX2, 8FS  
 Tel: +44 (0) 1392 823015

**UK Manufacturing Site**  
 Unit 2 Millyard Way, Eythorne, Dover, Kent CT15 4NL  
 Tel: +44 (0) 1304 831319

**USA Office**  
 Tel: +1 718 841 9940

[www.multipaneluk.co.uk](http://www.multipaneluk.co.uk)

# ACM Multipanel Setting Kongsberg

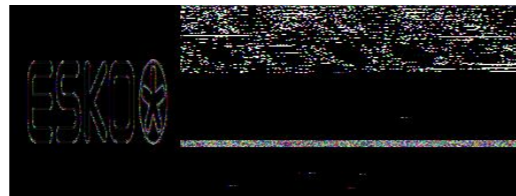

## Multipanel UK ACM

| Product                              | Alupanel   | A-Lite   | Alupanel Smart   | Multishield                             | V-Groove                         |
|--------------------------------------|--|--|--|---|----------------------------------|
| Thickness (mm)                       | 3  | 3  | 3  | 3                                       | 3                                |
| Skin type & thickness (mm)           | Aluminium 0.3  | Aluminium 0.2  | Aluminium 0.26   | Steel 0.25                              |                                  |
| Cutting bit diameter (mm)            | 4  | 4  | 4  | 4                                       | 1                                |
| Bit/No                               | BIT: MUS06-4006-50C1<br>Code: G42451112<br>BIT: MUS06-4006-50C2<br>Code: G42471722 | BIT: MUS06-4006-50C1<br>Code: G42451112<br>BIT: MUS06-4006-50C2<br>Code: G42471723 | BIT: MUS06-4006-50C1<br>Code: G42451112<br>BIT: MUS06-4006-50C2<br>Code: G42471724 | BIT: MUS06-4006-50C2<br>Code: G42471724 | BIT: EBV06-94<br>Code: G02731628 |
| Bit type                             | MU   | MU   | MU   | MU                                      |                                  |
| Spindle speed                        | 50,000-52,000  | 50,000-52,000  | 50,000-52,000  | 30,000                                  | 35,000                           |
| Speed X/Y m/min<br>Feed rate         | (8)-20   | (8)-20   | (8)-20   | 5                                       | 10                               |
| Speed Z m/min<br>plunge rate         | 1  | 1  | 1  | 1                                       | 1                                |
| Acceleration                         | 25   | 25   | 25   | 15                                      | 30                               |
| Multipass Y/N                        | N  | N  | N  | Y<br>2 PASS                             | N                                |
| Clockwise<br>or Counter<br>clockwise | CC   | CC   | CC   | CC                                      | Centreline                       |

| Part no | Description        | Cut diameter | Max speed |
|---------|--------------------|--------------|-----------|
| R204    | 4mm cutter         | 4mm          | 50,000    |
| R141    | 90 degree V-Groove | 10mm         | 40,000    |



**G3 cutter**  
Uncompromising performance and precision



- ✔ Modularity
- ✔ Upgradability
- ✔ Automatic tool/bit changes



The G3 Cutter is a precision machine. From innovative drive system to blade, all components are perfectly coordinated. Produce your jobs at the highest quality level, economically and efficiently. Your customers will be thrilled with the results.

## Recommended CNC Tooling For Multipanel ALUPANEL Composite Sheets

### Sign & Display

#### Multipanel ALUPANEL / ALUPANEL XT

##### Recommended Folding Tools

|                     |                       |              |                   |                |                           |
|---------------------|-----------------------|--------------|-------------------|----------------|---------------------------|
| <b>FC90 V-Fold</b>  | 90° Angle (Uncoated)  | 3mm Flat Tip | 4mm Max Cut Depth | 8mm Shank dia  | <a href="#">More Info</a> |
| <b>FC135 V Fold</b> | 135° Angle (Uncoated) | 3mm Flat Tip | 3mm Max Cut Depth | 12mm Shank dia | <a href="#">More Info</a> |

##### Recommended Cutting Profile Tools

|                    |                        |              |                    |           |                           |
|--------------------|------------------------|--------------|--------------------|-----------|---------------------------|
| <b>CPAL 3-6-6</b>  | Single Flute Up spiral | 3mm diameter | 6mm max cut depth  | 6mm shank | <a href="#">More Info</a> |
| <b>CPAL 4-8-6</b>  | Single Flute Up spiral | 4mm diameter | 8mm max cut depth  | 6mm shank |                           |
| <b>CPAL 6-14-6</b> | Single Flute Up spiral | 6mm diameter | 14mm max cut depth | 6mm shank |                           |

#### Multipanel Multishield Galvanized Steel Composite Sheet

##### Recommended Folding Tools

|                      |                                 |              |                   |               |                           |
|----------------------|---------------------------------|--------------|-------------------|---------------|---------------------------|
| <b>FC90DC V-Fold</b> | 90° Angle (Diamond Like Coated) | 3mm Flat Tip | 4mm Max Cut Depth | 8mm Shank dia | <a href="#">More Info</a> |
|----------------------|---------------------------------|--------------|-------------------|---------------|---------------------------|

##### Recommended Cutting Profile Tools

|                   |   |              |                    |               |                           |
|-------------------|---|--------------|--------------------|---------------|---------------------------|
| <b>SS40 6-7-6</b> | Triple Flute Coated Entry Hole Drilling | 6mm diameter | 7mm max cut depth  | 6mm shank dia | <a href="#">More Info</a> |
| <b>DCT 3-6-6</b>  | Twin Flute (Diamond Like Coated)        | 3mm diameter | 6mm max cut depth  | 6mm shank dia | <a href="#">More Info</a> |
| <b>DCT 4-8-6</b>  | Twin Flute (Diamond Like Coated)        | 4mm diameter | 8mm max cut depth  | 6mm shank dia |                           |
| <b>DCT 6-10-6</b> | Twin Flute (Diamond Like Coated)        | 6mm diameter | 10mm max cut depth | 6mm shank dia |                           |

### Architectural

#### Multipanel ALUPANEL FR / ALUPANEL XTFRHP (Fire Resistant Core)

##### Recommended Folding Tools

|                      |                                 |              |                   |               |                           |
|----------------------|---------------------------------|--------------|-------------------|---------------|---------------------------|
| <b>FC90 V-Fold</b>   | 90° Angle (Uncoated)            | 3mm Flat Tip | 4mm Max Cut Depth | 8mm Shank dia | <a href="#">More Info</a> |
| <b>FC90DC V-Fold</b> | 90° Angle (Diamond Like Coated) | 3mm Flat Tip | 4mm Max Cut Depth | 8mm Shank dia |                           |

##### Recommended Cutting Profile Tools

|                    |                                  |              |                    |               |                           |
|--------------------|----------------------------------|--------------|--------------------|---------------|---------------------------|
| <b>CPAL 3-6-6</b>  | Single Flute Up spiral           | 3mm diameter | 6mm max cut depth  | 6mm shank dia | <a href="#">More Info</a> |
| <b>CPAL 4-8-6</b>  | Single Flute Up spiral           | 4mm diameter | 8mm max cut depth  | 6mm shank dia |                           |
| <b>CPAL 6-14-6</b> | Single Flute Up spiral           | 6mm diameter | 14mm max cut depth | 6mm shank dia |                           |
| <b>DCT 3-6-6</b>   | Twin Flute (Diamond Like Coated) | 3mm diameter | 6mm max cut depth  | 6mm shank dia | <a href="#">More Info</a> |
| <b>DCT 4-8-6</b>   | Twin Flute (Diamond Like Coated) | 4mm diameter | 8mm max cut depth  | 6mm shank dia |                           |
| <b>DCT 6-10-6</b>  | Twin Flute (Diamond Like Coated) | 6mm diameter | 10mm max cut depth | 6mm shank dia |                           |

### Contact Us



Watch Video - Creating An ACM Folded Tray on a Tekcel EXR

Please Contact Complete CNC Solutions Ltd for a full range of CNC machines, tooling, cutters and accessories, along with all recommended cutting parameters and techniques for these materials.

Telephone: +44 (0) 1934 742 186  
 E-mail: [info@completecnc.co.uk](mailto:info@completecnc.co.uk)  
[www.completecnc.co.uk](http://www.completecnc.co.uk)



| CUTTERS FOR ALUMINIUM COMPOSITE |  |              |             |           |
|---------------------------------|--|--------------|-------------|-----------|
| Part no                         | Description                            | Cut diameter | Spindle rpm | Feed rate |
| 2091A-90-8                      | 90 degree V-groove                     | 20           | 21,000      | 4m/min    |
| 2091A-135-8                     | 135 degree V-groove                    | 20           |             |           |
| 2101A-10-8                      | 5mm radius spherical                   | 10           |             |           |
| 2101A-15-8                      | 7.5mm radius spherical                 | 15           |             |           |
| 1111A-4-6                       | 4mm Profile cutter                     | 4            | 21,000      | 1m/min    |
| 1111A-5-6                       | 5mm Profile cutter                     | 5            |             |           |
| 1111A-6                         | 6mm Profile cutter                     | 6            |             |           |
| CUTTERS FOR STEEL COMPOSITE     |  |              |             |           |
| 2131T-6                         | 6mm Profile cutter for steel composite | 6mm          | 21,000      | 4m/min    |



#### PANELBuilder

One process, one solution

##### At a Glance:

- Widths from 1,524mm to 2635mm
- Lengths from 1220mm to over 15m
- High-speed ACM processing
- Multiple tool configurations
- Dedicated CAD/CAM software
- **Primary Applications:** Aluminium & Metal Composite Cladding

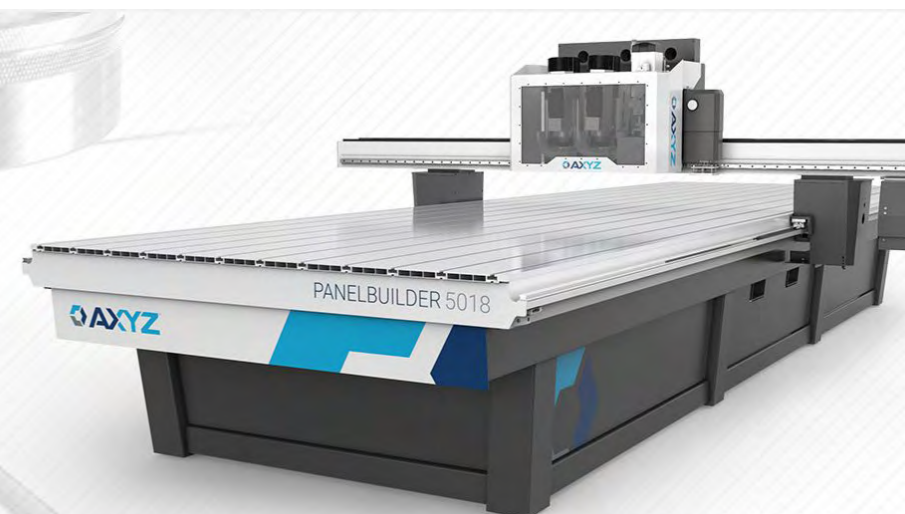



# Alupanel® Fabrication Settings: MultiCam



## 6mm Spiral O Upcut - Celero 5

| Production Feedrate | Max Feedrate  |
|---------------------|---------------|
| 575 IPM @ 35K       | 865 IPM @48K  |
| 244mm/s @ 35K       | 366mm/s @ 48K |



## 108 Degree ACm V Groove Bit - Celero 5

| Production Feedrate | Max Feedrate  |
|---------------------|---------------|
| 700 IPM @ 35K       | 960 IPM @ 48K |
| 296mm/s @ 35K       | 406mm/s @ 48K |

## 6mm Spiral O Upcut - Router

| Production Feedrate | Max Feedrate  |
|---------------------|---------------|
| 330 IPM @ 20K       | 550 IPM @ 30K |
| 140mm/s @ 20K       | 232mm/s @ 30K |



## 108 Degree ACm V Groove Bit - Router

| Production Feedrate | Max Feedrate  |
|---------------------|---------------|
| 400 IPM @ 20K       | 600 IPM @ 30K |
| 170mm/s @ 20K       | 254mm/s @ 30K |



[Apex3R cutting Aluminium Composite](#)

www.multicam.com

+1 972.929.4070



# Alu Ranger VGroove

CNC Panel Router with Vertical Table



60% less floorspace required than for a horizontal router system  
 Panel vacuum hold down system  
 Dedicated rotary v-groove cutter - no tool changes

## VGroove CUTTERHEAD



VGROOVE \_ Ø 175 mm  
 Z 10+10 WIDIA (std)

processing speed (PE core):  
 up to 50 m/minute  
 1969 IPM

## FLUTE TOOLC



Ø 4 mm WIDIA Ø 6 mm WIDIA Ø 10 mm WIDIA

processing speed (PE core):  
 up to 12 m/minute  
 472 IPM

## CIRCULAR SAWBLADE



AGGREGATE WITH WIDIA CIRCULAR SAWBLADE \_ Ø 125 mm

processing speed (PE core):  
 up to 50 m/minute  
 1969 IPM

# Alu Ranger oneR

CNC panel router with vertical table



## FLUTE TOOL



Ø 4 mm WIDIA Ø 6 mm WIDIA Ø 10 mm WIDIA

processing speed up to 12 m/1' (core in PE)

## CIRCULAR SAWBLADE

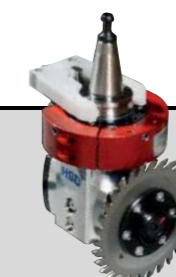

AGGREGATE WITH CIRCULAR SAWBLADE\_ Ø 125 mm  
 processing speed (PE core):  
 up to 30 m/minute

## ROUTER VGROOVE



AGGREGATE WITH ROUTER VGROOVE \_ Ø 125 mm  
 processing speed (PE core):  
 up to 30 m/minute

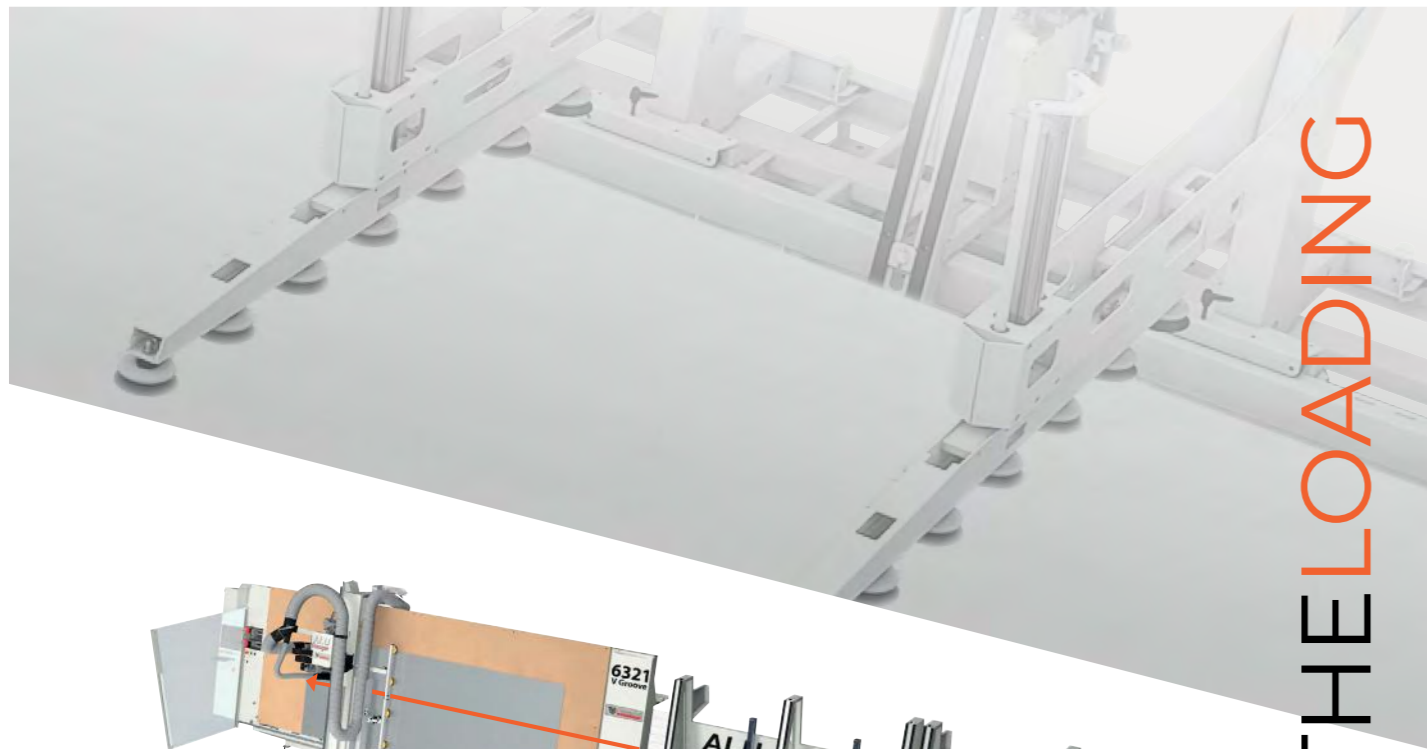

I DO ALL THE LOADING

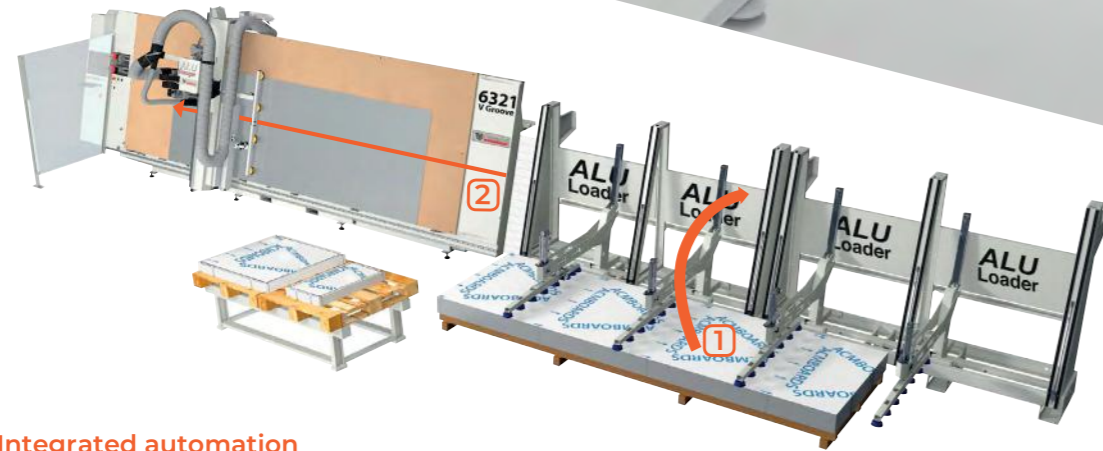

**Integrated automation**

- Automatic loading and positioning without operators
- Increased productivity
- Zero risk of panels falling from table
- Ergonomically designed for easy panel off-loading

- 1 Loading
- 2 Positioning

**ALU LOADER**

42 / 63 / 101  
Automatic panel loader  
for Alu Ranger (Opt.)

**PATENTED**

www.casadei-industria.com

**ALU FEEDER**

Automatic panel positioning  
system for Alu Ranger (Opt.)

Automatic loading of the panels  
with holding arms and suction cups connected  
to the vacuum holding system of Alu Ranger



**Alu Ranger  
V-Groove**

CNC Panel Router  
with Vertical Table



60% less floorspace required than for a horizontal router system  
Panel vacuum hold down system  
Dedicated rotary v-groove cutter - no tool changes

**V-Groove  
CUTTERHEAD**



VGROOVE \_ Ø 175 mm  
Z 10+10 WIDIA (std)

processing speed  
(PE core):  
up to 50 m/minute  
1969 IPM

**FLUTE TOOL**



Ø 4 mm WIDIA  
Ø 6 mm WIDIA  
Ø 10 mm VGROOVE WIDIA

processing speed  
(PE core):  
up to 12 m/minute  
472 IPM

**CIRCULAR SAWBLADE**



AGGREGATE WITH  
WIDIA CIRCULAR SAWBLADE \_ Ø 125 mm

processing speed  
(PE core):  
up to 50 m/minute  
1969 IPM

**Alu Ranger  
oneR**

CNC panel router  
with vertical table

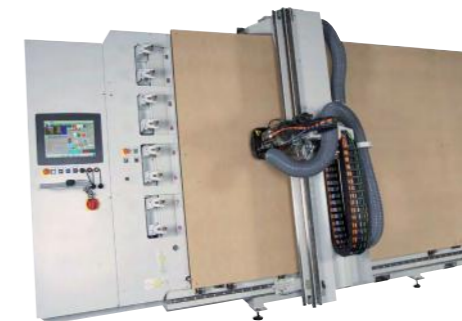

**FLUTE TOOL**



Ø 4 mm WIDIA  
Ø 6 mm WIDIA  
Ø 10 mm VGROOVE WIDIA

processing speed  
up to 12 m/1' (core in PE)

**CIRCULAR SAWBLADE**



AGGREGATE WITH  
CIRCULAR SAWBLADE \_ Ø 125 mm  
processing speed (PE core):  
up to 30 m/minute

**ROUTER  
VGROOVE**



AGGREGATE WITH ROUTER  
VGROOVE \_ Ø 125 mm  
processing speed (PE core):  
up to 30 m/minute

# SR5UA

MADE IN THE USA



## Panel Saw/Router Combo

The SR5UA panel saw/router combo allows operators to saw and rout on one vertical steel frame. The unique design of this unit allows for accurate cutting and v-grooving of ACM (Aluminum Composite Material) panels. Features a unique floating router with a nylon guide guaranteeing a consistent depth of cut. The router and saw can be interchanged in less than one minute. It also features a dust system in place to collect debris while cutting and routing. Tooling included with machine.

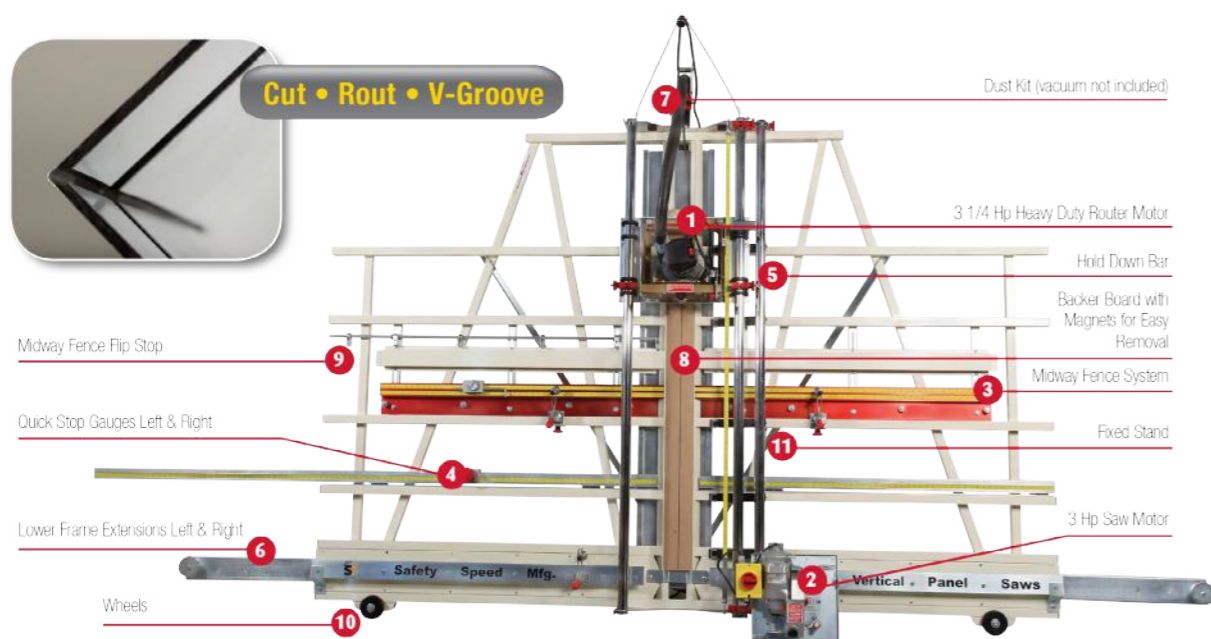

| SPECIFICATIONS                    |                |        |
|-----------------------------------|----------------|--------|
| Max. Crosscut                     | 62"            | 1575mm |
| Max. Rip Cut                      | Unlimited      |        |
| Max. Cut Thickness                | 1 3/4"/44mm    |        |
| Cut Accuracy, Straight and Square | 1/64"/1.4mm    |        |
| Saw Blade Diameter                | 8"/200mm       |        |
| Motor*                            | 120V, 13 amp   |        |
| Router*                           | 120V, 15 amps  |        |
| Frame Length                      | 120"/3050mm    |        |
| Shipping Weight                   | 687 lbs/311 kg |        |

● All items with numbers are included with this machine  
\* 220V motors available



"Our Safety Speed Panel Saw/Router is one of the best pieces of equipment we have purchased in a long time. It is so easy, and safe to use I have my first year students using it."  
—Lee Matthews, Houston, TX



www.signsaw.com • 800-772-2327

## Extended SteelTrak TW Cutting Head for Steel or Aluminium Composite Panels



### Responding to customer requests

Extended SteelTrak TW Cutting Head for Steel or Aluminium Composite Panels (STC2C)

A number of our end-users have asked us to create a cutting head to cut Steel Composite Panels within tight flatness tolerances. In response our designer developed a new larger (extended) twin wheel cutting head suitable for both Steel and Aluminium Composite Panels (STC2C).

After initial trials with Steel Composite Panels, we decided to try it on Aluminium Composite Panels and found that it dramatically reduced the bending of the ACP on the left hand side of the cut; this makes it perfect for cutting panels for processing on flatbed printers.

The Extended SteelTrak TW Cutting Head is suitable for up to 3mm Steel or 4mm Aluminium Composite Panels

If you would like more information on the STC2C please contact us at [sales@keencut.co.uk](mailto:sales@keencut.co.uk)



T +44 (0)1536 263158  
E [sales@keencut.co.uk](mailto:sales@keencut.co.uk)  
www.Keencut.com



Using a Keencut SteelTrak for cutting and grooving

**General fabrication guidelines**

|   |                 |
|---|-----------------|
| Bit size  | 4mm             |
| Pass depth  | 10mm            |
| Stepover  | 1.8mm           |
| Spindle speed (Steel rpm needs to be lower than on aluminium) | 12000-24000 rpm |
| Feed rate   | 35mm/sec        |
| Plunge rate   | 15mm/sec        |

**LKH Tools Recommended Fabrication guidelines (tested using Crown Norge Tools)**

|   |                        |
|---|------------------------|
| Bit size (grooving)   | 10mm ball nose         |
| Bit size (cutting out)  | 3 or 4mm               |
| Spindle speed   | 12000-18000 rpm        |
| Feed rate   | 3m/minute (50mm/sec)   |
| Plunge rate   | 0.5 m/minute (8mm/sec) |
| Recommended tools: B1-10.0/-10-10-50 MP B Superior - grooving tool<br>S1-3.0/6-6-50 MP Superior - 3mm cut out tool or S1-4.0/6-6-50 4mm |                        |

**Cutting with saws (including panel saws):**

Standard blades for soft materials can be used but will have a limited life-span, being quickly worn by the steel. Cutting life is better for steel blades but these generate incandescent chips which can become hazardous if the suction system sends them to the same tank as dust and chips from traditional plastic materials as there is the risk of smouldering. Solutions include either cutting the suction or utilising a second bin for use when cutting Multishield.

**Cutting with a guillotine:**

Guillotine cutting (industrial sheet metal) works very well as the method is designed for cutting steel and does not produce chips or sparks. The result at the level of the slice will depend on the shape and thickness of the guillotine's knife which will cause variations in the amount of "crush" on the material edge. We recommend you test to confirm whether the aesthetic is suitable for your needs.

# Notes

---

---

---

---

---

---

---

---

---

---

---

---

---

---

---

---

---

---

---

---

---

---

---

---



# MULTIPANELUK<sup>LTD</sup>

*a multitude of applications*



[www.multipaneluk.co.uk](http://www.multipaneluk.co.uk)